

SENSITIVE EDGE TYPE “B2C-AGB”

The edge type B2C-AGB differs from type B2C in the anchoring foot, which has been studied to make it interchangeable with most of profiles on the market, and for its completion accessories.

TYPE B2C-AGB
with lips and
universal foot

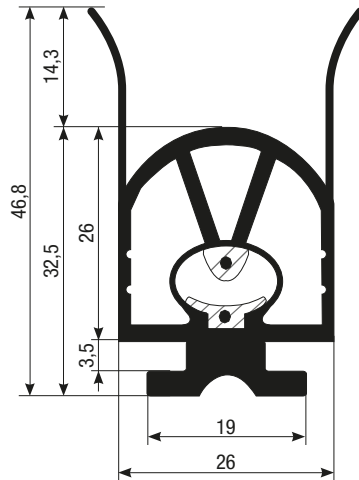

Roll of 25 m

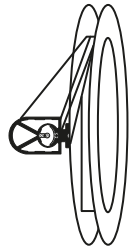

ROLL OF 25 M

Please order the single components according to the following this pattern:

- 1 Pack of **profile type B2C-AGB** (standard roll 25 meters)
- 1 **Kit end cap/needle connectors** type KC2 (1 end cap/connector with electric cable type KC2C + 1 end cap/connector with resistance type KC2R).
- 1 **aluminium support** with unit of measure in linear meters (type SAC25 – CAL25 – SAI25 for edge fastening)
- 1 **Primer** bottle (10ml) code PR
- 1 **Sealant** bottle (10ml) code CY

KC2C | End cap/connector with cable | Length 3 meters

KC2R | End cap/connector with resistance | Pack of 2 pcs.

Double end cap/connector with cable | Length 0.4 meters

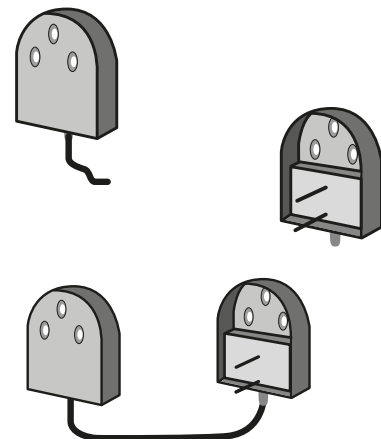

ALUMINIUM SUPPORT FOR EDGE FASTENING

The fastening is carried out by installing the edge on a suitable aluminium support.
Three types of support are available.

Type “SAC25” | “C”-shaped profile | for edges type B2C-AGB

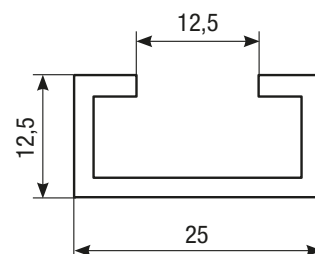

Type "SAL25" | "L"-shaped profile | for edges type B2C-AGB

Type "SAI25" | "I"-shaped profile for edges type B2C-AGB

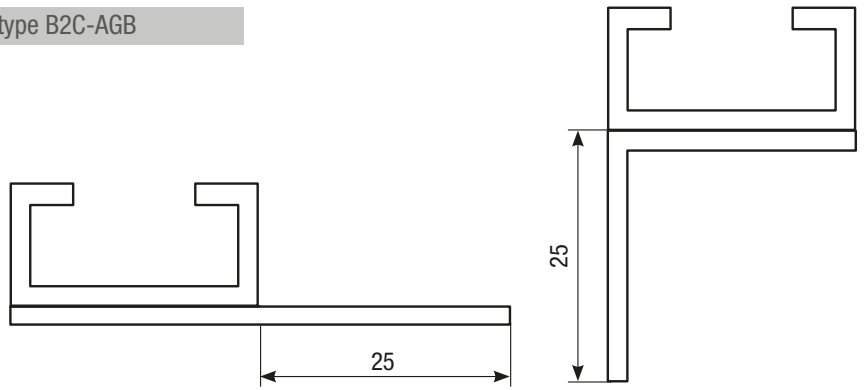

SUPPLY CABLE OUTLET

"UI" | Bottom side outlet

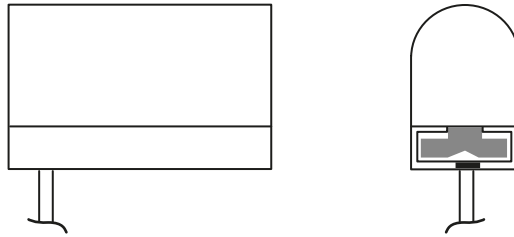

"CCCC" | Double outlet

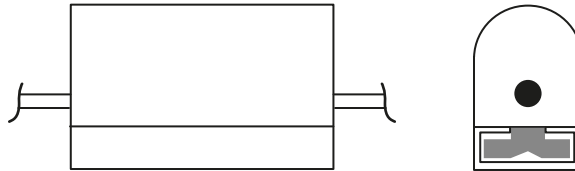

SEALANTS FOR "DO-IT-YOURSELF" EDGES

"GSBPR" | Primer bottle (10ml) type PR

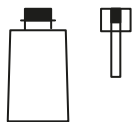

"GSBCY" | Sealant bottle (10ml) type CY



HOW TO ORDER AN EDGE TYPE "B2C-AGB" (ASSEMBLED)

Code

